

# GV-1 SERIES

HEAVY-DUTY VERTICAL CNC TURNING CENTERS



THE ULTIMATE MACHINING POWER  
**WOODWAY**



# GV-1 series

## HEAVY-DUTY VERTICAL TURNING CENTERS

/// **EXTREMELY LOAD CAPACITY**

/// **ABUNDANT PROCESSING AREA**

/// **FLEXIBLE MOVING CROSS RAIL STRUCTURE**

Packed with advanced composition and high class core element to bring GV-1 series with high rigidity and heavy-duty cutting capabilities.

GV-1 series can meet request of every heavy work piece and tough material.

**A**

| Table Diameter     |
|--------------------|
| GV-1100 : 1,100 mm |
| GV-1200 : 1,250 mm |
| GV-1600 : 1,600 mm |
| GV-2000 : 2,000 mm |

**B**

| Max. Turning Diameter |
|-----------------------|
| GV-1100 : 1,200 mm    |
| GV-1200 : 1,350 mm    |
| GV-1600 : 1,800 mm    |
| GV-2000 : 2,000 mm    |

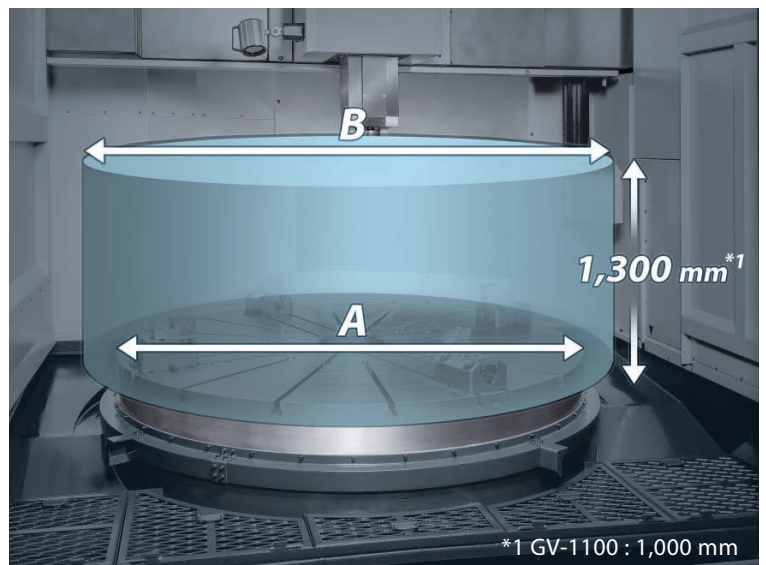



( GV-1200M model shown with optional accessories )



# MAXIMUM STRENGTH CONSTRUCTION

## Finite Element Analysis ( FEA )

The Finite Element Analysis ( FEA ) provides optimal machine design and light-weight structure advantage while ensuring super rigid of machine.

## Super Rigid Casting Structure

The super rigid bed and column are of MEEHANITE casting. It is capable of withstanding much greater stress without deforming and provides maximum vibration dampening.



( Casting structure of GV-1600M model shown )

## Reinforced Rib Column

Reinforced rib column integrated with cross rail stay firmly on the machine base that provide spindle head abundant support rigidity, also shorten the distance between tooling to the column and reduce tooling spindle overhang, strengthen processing rigidity.

## High Precision Hand Scraping

Contact surfaces of all slides, bed and column are precision hand scraped to provide maximum assembly precision, structural rigidity, and load distribution.

## Heavy Duty Ground Box Ways

Extra wide hardened and ground box ways on X, Z and W axes. They are precision machine and widely spaced for maximum strength. The box way design also provides the rigidity needed for heavy duty and interrupted turning applications.

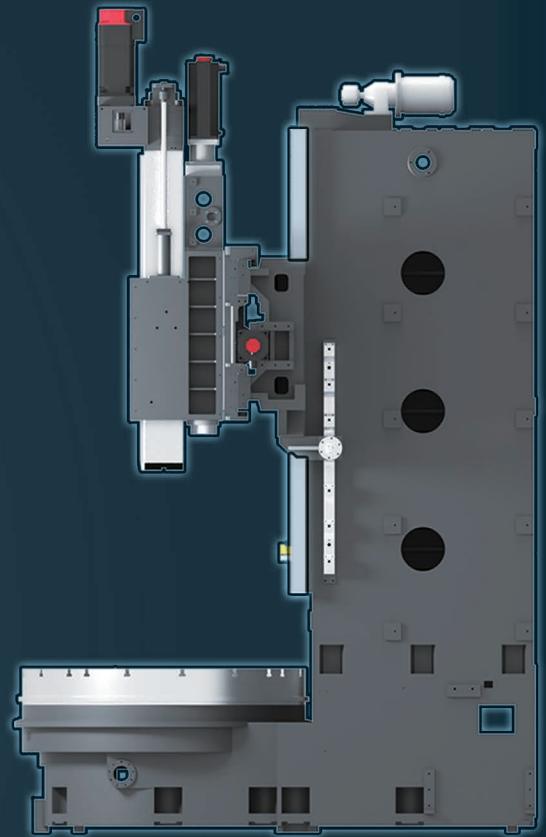

## W-axis Moving Cross Rail Mechanism

By W-axis moving ram to reduce the distance between tooling and beam, this can decrease square ram overhang, suitable for heavy cutting or disc type parts request.

W-axis travel : 600 mm ( GV-1100 )  
800 mm ( GV-1200 ~ GV-2000 )

### Positioning & Clamping Mechanism

Positioning fixed device is composed of two sets of live locking bolts and four sets of hydraulic clamping devices which can provide abundant clamping force, decrease vibration when cutting, ensure processing accuracy.

### Sectional Guide Ways Design

Not only W-axis rail integrated with column, also use new sectional design to provide good anti-vibration capability, construction not deformed during heavy cutting.

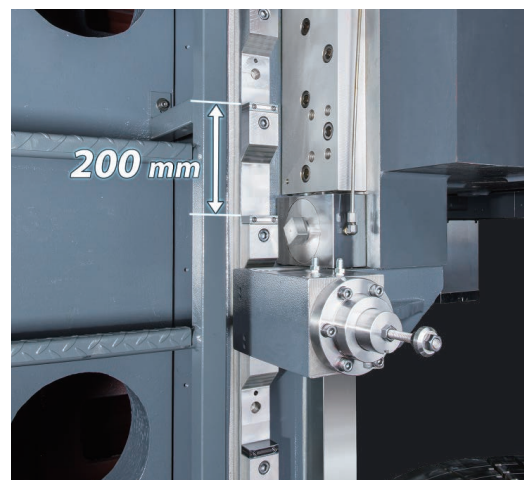



# ULTIMATE TURNING POWER

## Super-sized Square Ram

The square ram on the tooling spindle is adopted with a closed-type and fixed with 8 sets of powerful wedges. This offer the GV-1 series with greater structural rigid and machining accuracy compared peer models with a semi-closed type square ram structure.

Z-axis is balanced by dual counterweight hydraulic cylinder, this can avoid unbalanced torque and make sure GV-1 excellent processing accuracy.



Semi-closed Type Square Ram  
( Peer models )

Closed-type Square Ram  
( GV-1 series )



Unit : mm

## Coolant & Chip Removal Capacity

Machine standard include coolant through spindle and coolant around spindle. High pressure coolant system ( 70 bar ~120 bar ) is optional function.

Wide chip trough is designed by large angle of inclination, by working with chips wash down coolant system, chips can be easily brought out through cutting area.

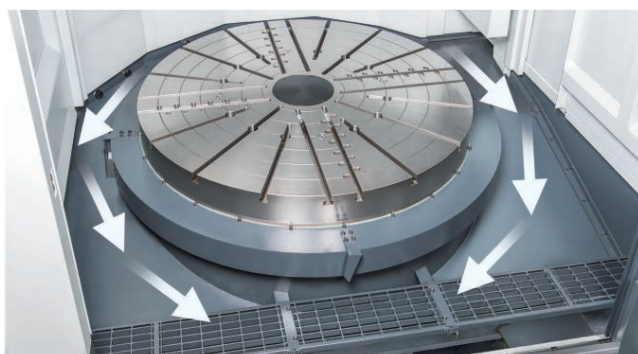

## Max. Clamping Range

Standard 4-jaws individual manual chuck.

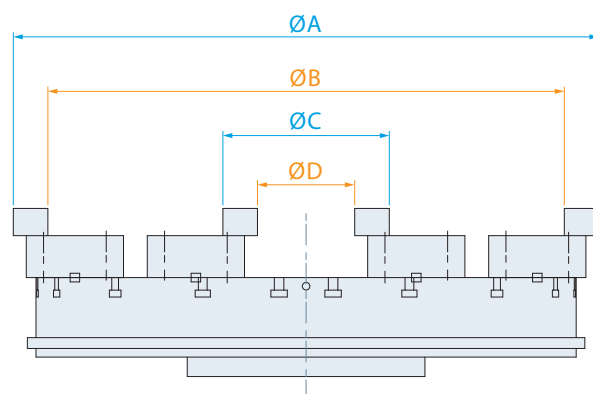

Unit : mm

| Max. clamping range | A     | B     | C   | D   |
|---------------------|-------|-------|-----|-----|
| GV-1100             | 1,165 | 1,005 | 355 | 195 |
| GV-1200             | 1,355 | 1,195 | 385 | 225 |
| GV-1600             | 1,675 | 1,515 | 385 | 225 |
| GV-2000             | 1,995 | 1,835 | 385 | 225 |

## High Torque Work-piece Spindle

The high torque work-piece spindle is equipped with a powerful FANUC 45 kW spindle motor that delivers a maximum torque output of 23,900 Nm\*<sup>1</sup> at 18 rpm, ideal for heavy-duty cutting conditions.

The super rigidity, high rotation accuracy cross roller bearing can sustain radial, axial and torque compound loads to ensure machining accuracy under long-term heavy work loads and extend the service life of the spindle.

\*1 : GV-1600 / GV-2000 series

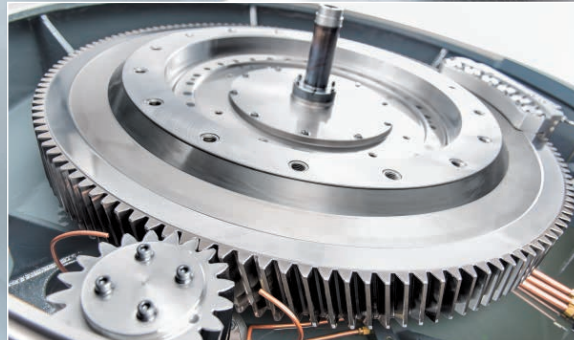

## Work-piece Spindle Output

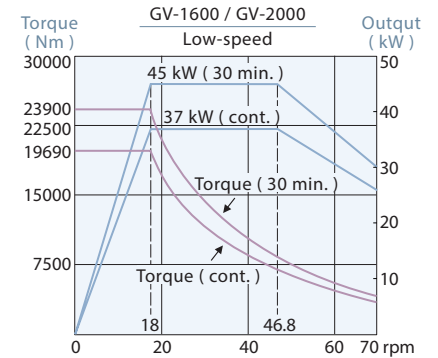
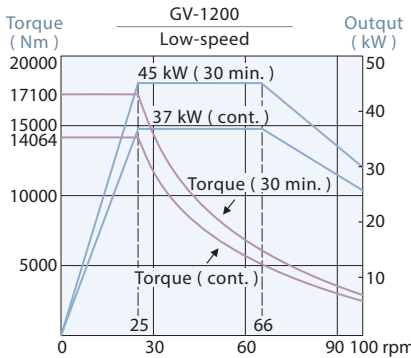
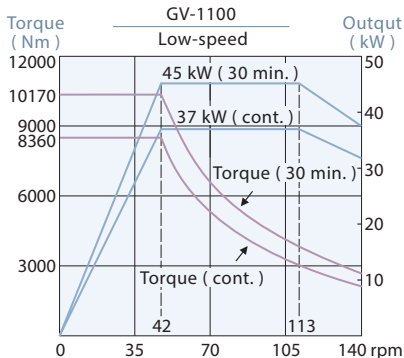
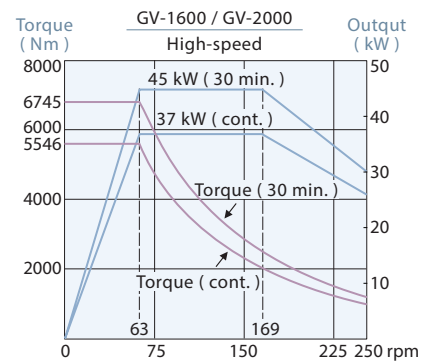
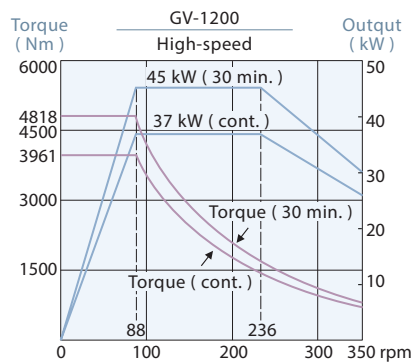
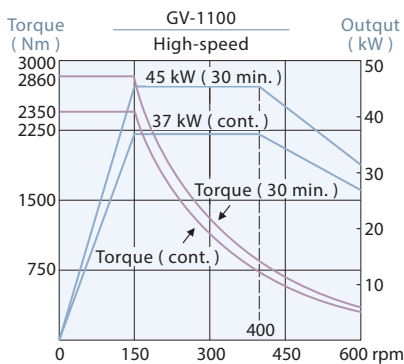



# POWERFUL MACHINING CAPACITY

Optional live tooling spindle and C-axis can provide turning, milling, drilling, tapping and other complex processing capacity. This can increase production efficiency, also can avoid setting error when parts moving between machines.

## Live Tooling Spindle

High power FANUC spindle motor and two-step gear box design, max. turning speed 2,400 rpm can provide high torque output in low speed to satisfy heavy cutting request.

High accuracy, high rigidity P4 class NN type dual roller bearing design, this can bear high load from axial and radial, even spindle working long time can also keep best accuracy.



Opt. 90° Milling Head



Opt. Universal Milling Head



## Live Tooling Spindle Output

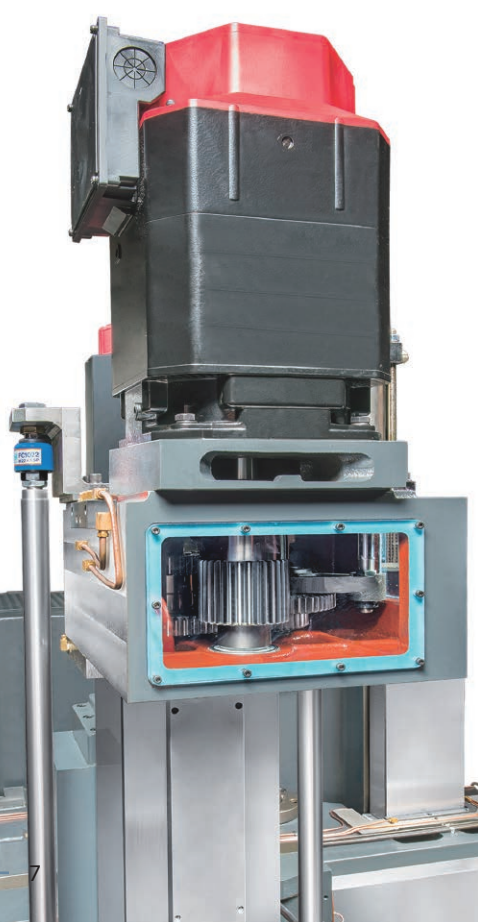
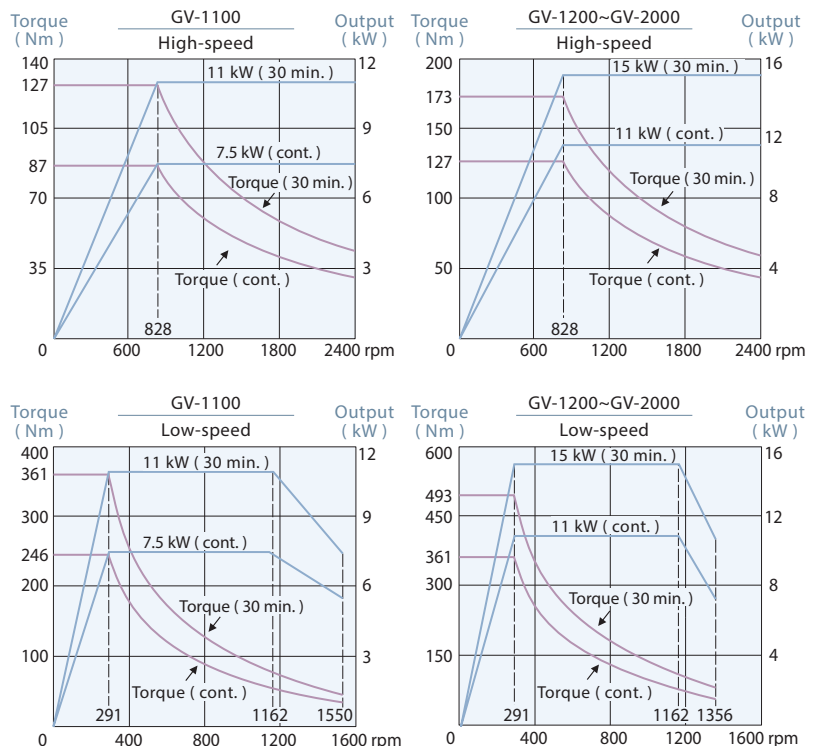



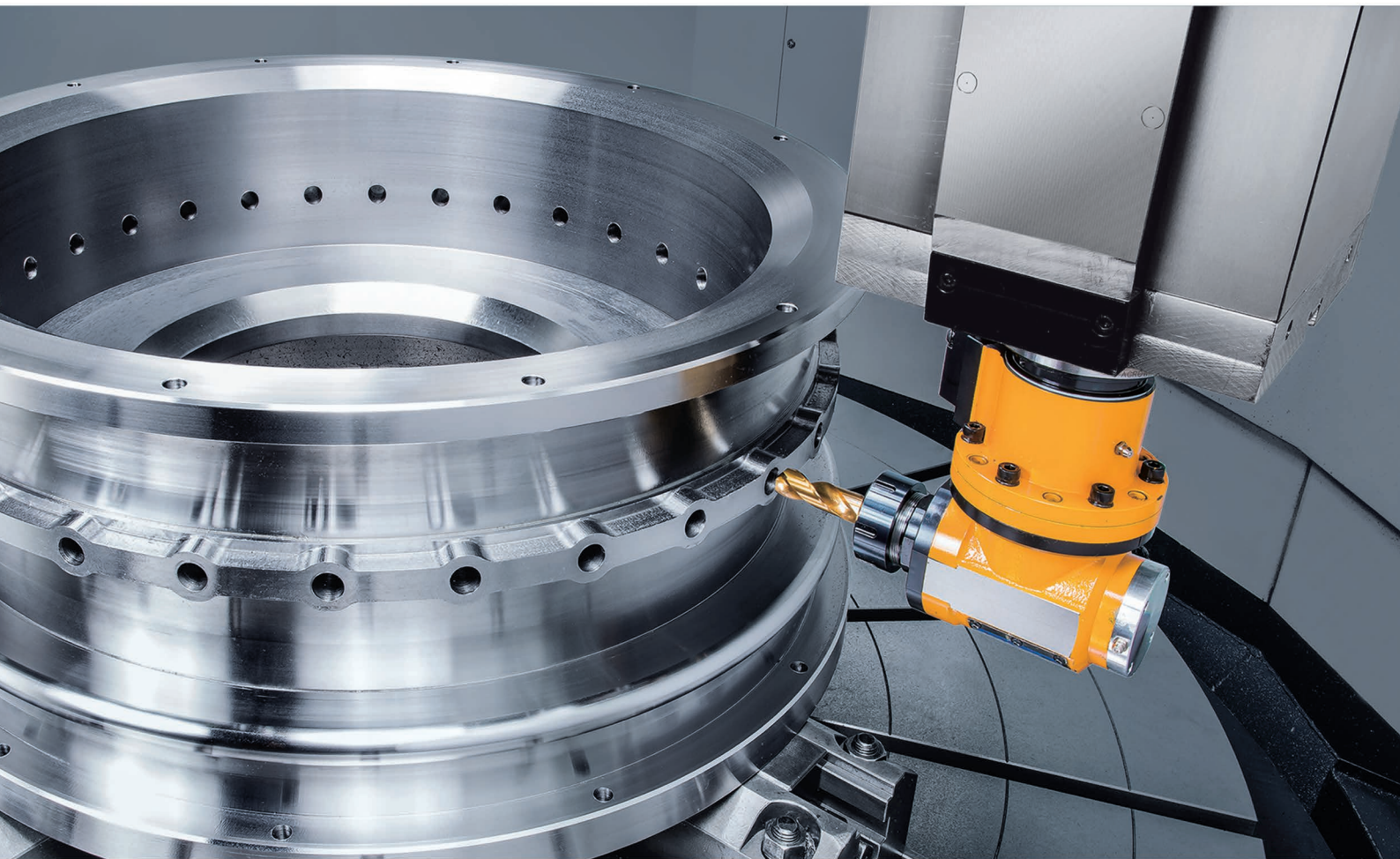

## Ultimate C-axis Spindle

Cf-axis is driven by ultra high resolution servo motor. It is adopted with worm gear drive system for high accuracy transmission and easy backlash adjustment. The indexing accuracy is up to  $0.001^\circ$ .

Standard disk brake system provide quick reacting and adequate locking force to satisfy rigid request when heavy cutting.

| Model   | Cf-axis torque output |
|---------|-----------------------|
| GV-1100 | 2,280 Nm              |
| GV-1200 | 2,740 Nm              |
| GV-1600 | 3,840 Nm              |
| GV-2000 | 3,840 Nm              |

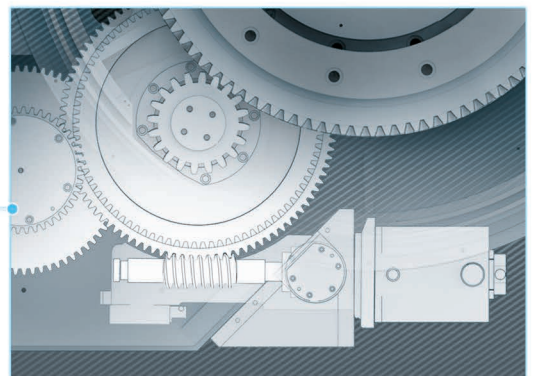

# OPTIMIZED EQUIPMENT

## ATC System

High reliable BT50 12 / 16 / 24 T umbrella type ATC system which providing 50 kg maximum tool weight and 360 kg maximum magazine loading capability.

Fully enclosed ATC door only opened when tool change. ATC won't be damaged by cutting chips that can make sure tool changing reliability.

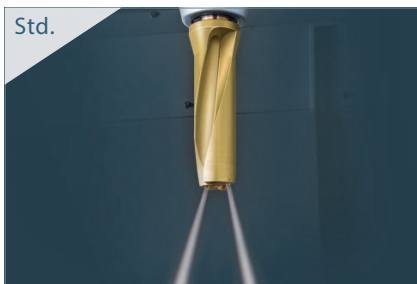
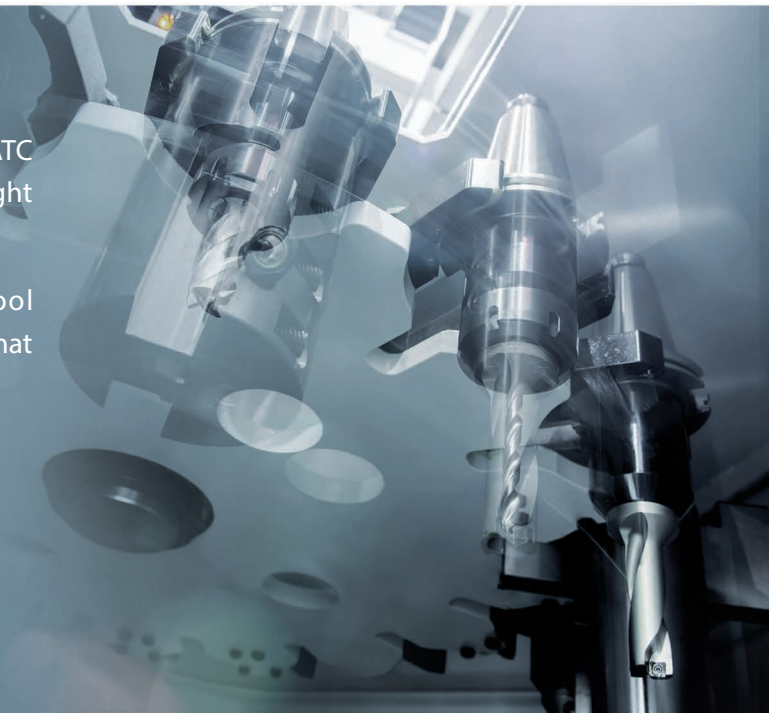
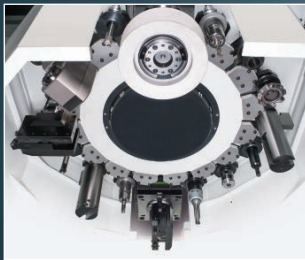

Coolant Through Spindle



Automatic Tool Length Measurement



Workpiece Inspection Probe

## High Pressure Coolant System Option

Max. Pressure : 70 ~ 120 bar ( 1,000 ~ 1,750 PSI )

Max. Flow Rate : 30 ~ 75 LPM ( 8 ~ 20 GPM )

Coolant Type : Water or Oil

- ▶ Pressure output monitoring system
- ▶ Filter replacement checking
- ▶ Super large capacity coolant tank
- ▶ Patented diaphragm pump ( made in USA. )
- ▶ Touch screen of human machine interface



## Intelligent Automatic Pressure Control

- Pressure controlled by programmable valve control, no need to be adjusted by manual, more accurate pressure output.
- It is controlled by closed loop of inverted motor, it can be adjusted to proper flow automatically by pressure to save power and decrease heat raising of coolant.\*<sup>1</sup>

- Use Ethernet to connect\*<sup>2</sup> with machine, easy wiring and setting, save cost of purchasing hardware.

\*<sup>1</sup> Traditional manual adjusting way is constant frequency full flow output.

\*<sup>2</sup> Only FANUC / SIEMENS controller



# G.LINC 350 Option

## Makes Your Machine Smarter

- ▶ Advanced Hardware
- ▶ Outstanding Operability
- ▶ Streamlined Programming
- ▶ High Security and Shortened Machining Setting
- ▶ Reliable Continuous Operation
- ▶ Shortened Troubleshooting Time
- ▶ Improved Utilization Rate
- ▶ 3D cutting simulation preview



## Significant Production Efficiency

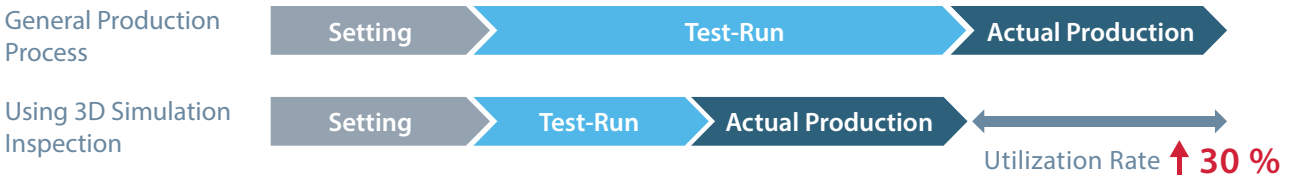

## Comprehensive Functions

| Programming  | Setting                                     | Test-Run  | Actual Production  | Daily Used  |
|--|---|---|--|---|
| Dynamic graphic display<br>Program management<br>Friendly programming environment<br>Programming auxiliary<br>Manual Guide <i>i</i><br>Embedded E-manual | 3D advance tool path and cutting simulation | Tool load monitor<br>Program check<br>Smart balance detection<br>3D Real-time cutting simulation and interference check | Tool load monitor<br>3D Real-time cutting simulation and interference check<br>load monitoring | Safety signal viewer<br>Fast alarm check productivity<br>Productivity management<br>Twin operation system switch<br>Maintenance management<br>NFC apply authority management and record |

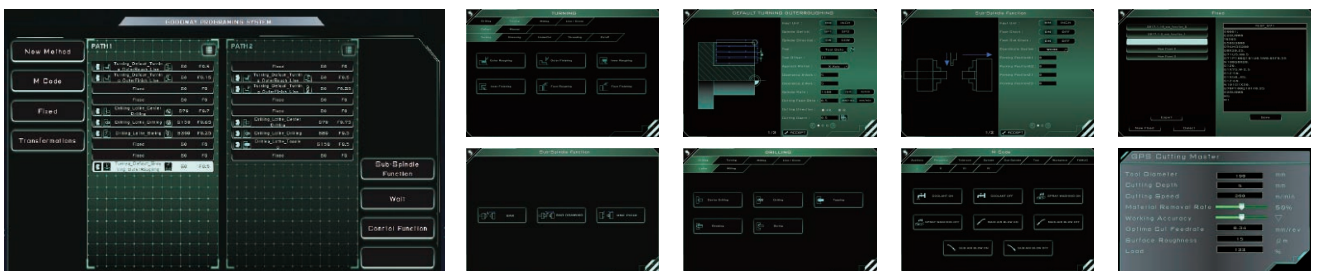

# GENERAL DIMENSION

## Tool Holders

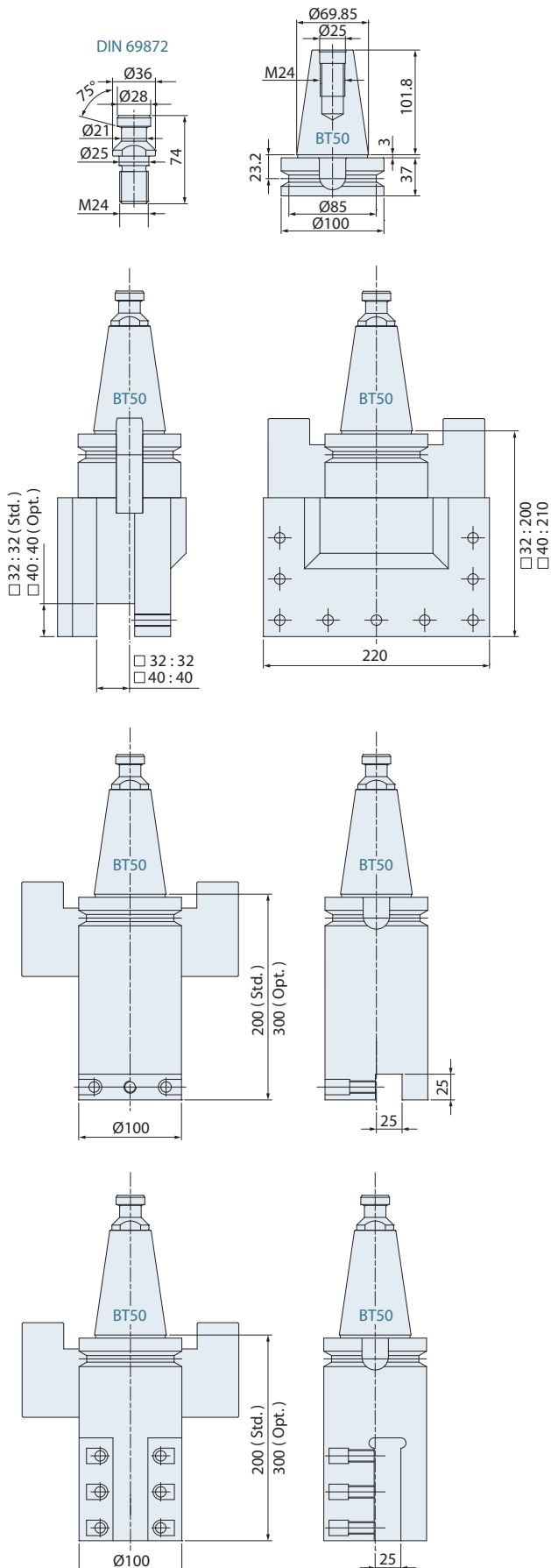

## Tool Holders ( Optional )

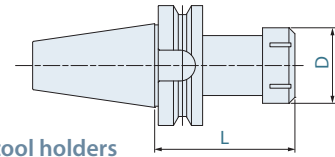

### Tapping tool holders

| Model      | L   | D   | Tapping Range |
|------------|-----|-----|---------------|
| BT50-TER16 | 80  | Ø28 | M3-M12        |
| BT50-TER40 | 117 | Ø63 | M12-M35       |

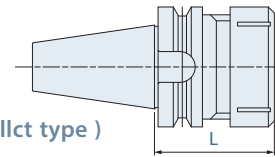

### Drilling ( collet type ) tool holders

| Model         | L   | Capacity | Collet Type |
|---------------|-----|----------|-------------|
| BT50-ER20-100 | 100 | 1-13     | ER20        |
| BT50-ER32-100 | 100 | 2-20     | ER32        |
| BT50-ER40-100 | 100 | 3-26     | ER40        |

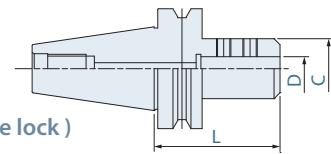

### Drilling ( side lock ) tool holders

| Model            | L   | C   | D     |
|------------------|-----|-----|-------|
| BT50-SLA20-105   | 105 | Ø50 | Ø20   |
| BT50-SLA25-105   | 105 | Ø55 | Ø25   |
| BT50-SLA32-105   | 105 | Ø60 | Ø32   |
| BT50-SLA40-105   | 105 | Ø80 | Ø40   |
| BT50-SLA50.8-105 | 105 | Ø95 | Ø50.8 |

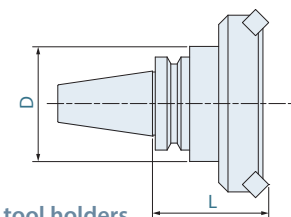

### Face milling tool holders

| Model             | L   | D   | Cutter Dia. |
|-------------------|-----|-----|-------------|
| BT50-FMA25.4-105  | 125 | Ø85 | Ø80         |
| BT50-FMA31.75-105 | 127 | Ø85 | Ø100        |
| BT50-FMA38.1-75   | 98  | Ø95 | Ø125        |
| BT50-FMA50.8-75   | 99  | Ø95 | Ø150        |

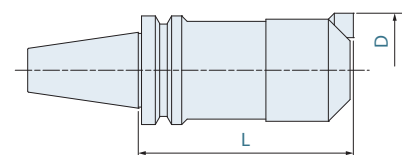

### Boring tool holders

| Model           | L   | D        |
|-----------------|-----|----------|
| BT50-BSA62-300  | 300 | Ø62~90   |
| BT50-BSA72-320  | 320 | Ø72~110  |
| BT50-FMA105-195 | 195 | Ø105~160 |

Unit : mm



## Tooling System

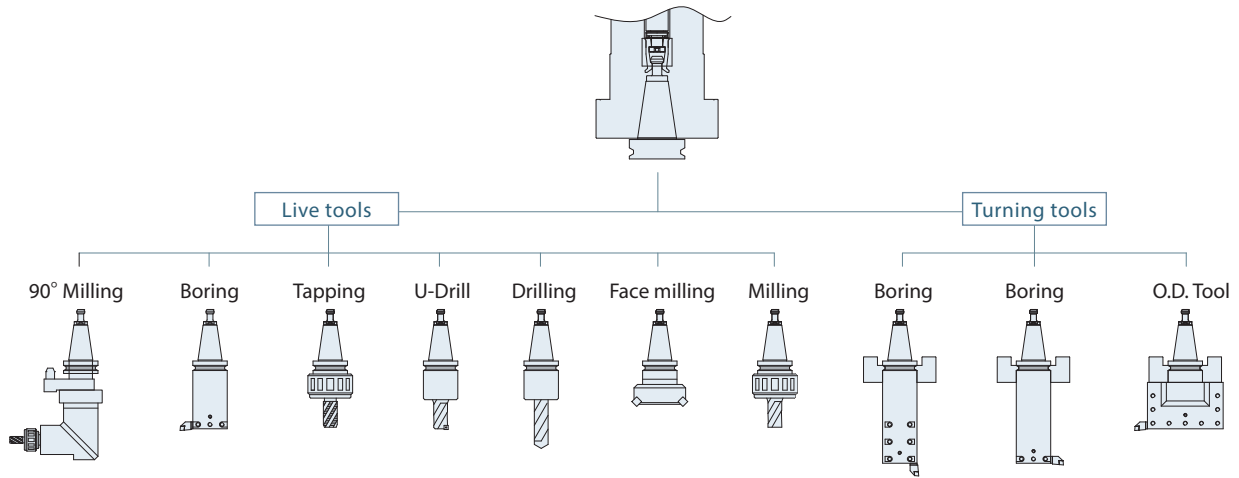

## Work Range

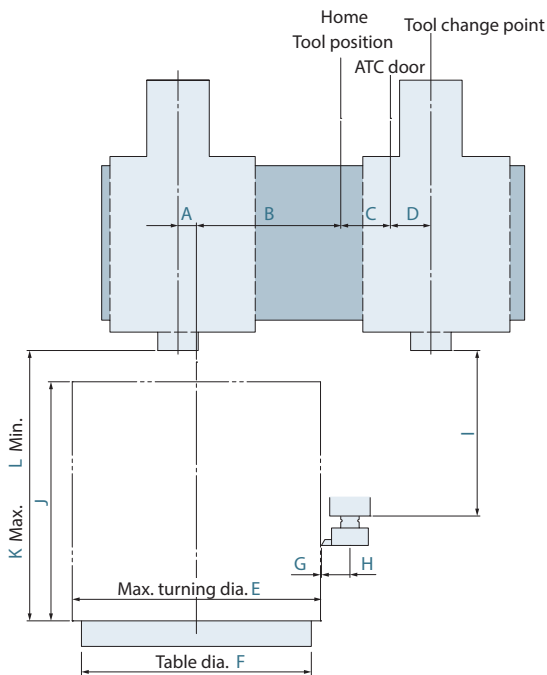

Min. inner turning dia.

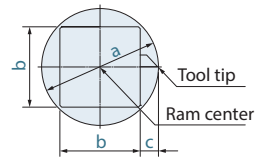

| Model   | a    | b   | c  |
|---------|------|-----|----|
| GV-1100 | Ø320 | 220 | 50 |
| GV-1200 | Ø320 | 220 | 50 |
| GV-1600 | Ø320 | 220 | 50 |
| GV-2000 | Ø320 | 220 | 50 |

| Model   | A   | B     | C   | D   | E      | F      |
|---------|-----|-------|-----|-----|--------|--------|
| GV-1100 | 100 | 760   | 220 | 220 | Ø1,200 | Ø1,100 |
| GV-1200 | 100 | 835   | 220 | 220 | Ø1,350 | Ø1,250 |
| GV-1600 | 100 | 1,060 | 220 | 220 | Ø1,800 | Ø1,600 |
| GV-2000 | 100 | 1,160 | 220 | 220 | Ø2,000 | Ø2,000 |

| Model   | G | H   | I   | J     | K     | L   |
|---------|---|-----|-----|-------|-------|-----|
| GV-1100 | 5 | 155 | 900 | 1,000 | 1,400 | 800 |
| GV-1200 | 5 | 155 | 900 | 1,300 | 1,550 | 750 |
| GV-1600 | 5 | 155 | 900 | 1,300 | 1,550 | 750 |
| GV-2000 | 5 | 155 | 900 | 1,280 | 1,530 | 730 |

Unit : mm

## Machine Layout

| Model   | A     | B     | C     |
|---------|-------|-------|-------|
| GV-1100 | 3,485 | 5,050 | 4,450 |
| GV-1200 | 3,540 | 5,300 | 4,500 |
| GV-1600 | 3,790 | 5,300 | 4,500 |
| GV-2000 | 4,400 | 5,300 | 4,500 |

| Model   | D   | E   | F     |
|---------|-----|-----|-------|
| GV-1100 | 910 | 600 | 1,265 |
| GV-1200 | 930 | 800 | 1,315 |
| GV-1600 | 910 | 800 | 1,350 |
| GV-2000 | 930 | 800 | 1,500 |

| Model   | G     | H     | I     |
|---------|-------|-------|-------|
| GV-1100 | 3,530 | 3,310 | 4,460 |
| GV-1200 | 3,195 | 3,580 | 4,730 |
| GV-1600 | 3,450 | 3,560 | 4,750 |
| GV-2000 | 3,600 | 3,560 | 4,750 |

Unit : mm

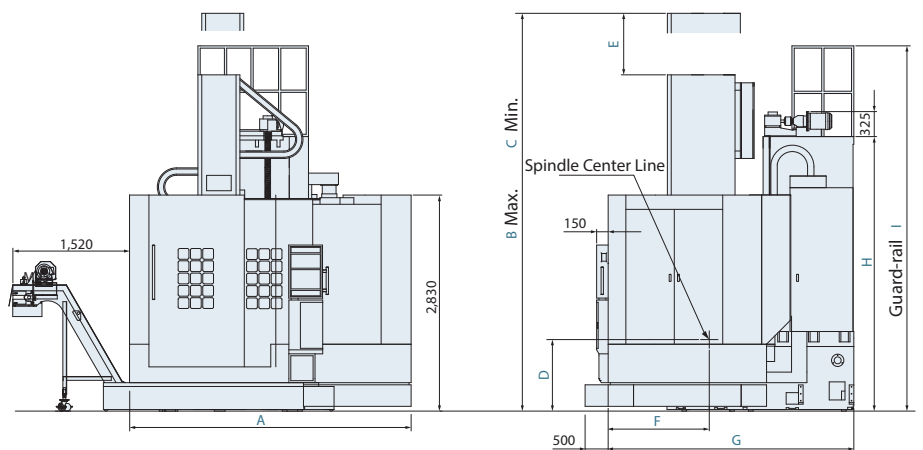

Specifications are subject to change without notice.

# STANDARD & OPTIOANL FEATURES

S : Standard      O : Option  
 - : Not Availabl    C : Contact GOODWAY

|   |                       | GV-1100 | GV-1200 | GV-1600 | GV-2000 |
|---|-----------------------|---------|---------|---------|---------|
| <b>WORK PIECE SPINDLE</b>                     |                       |         |         |         |         |
| Main spindle                                  |                       | S       | S       | S       | S       |
| Rigid tapping                                 |                       | S       | S       | S       | S       |
| Cf-axis                                       |                       | O       | O       | O       | O       |
| Disk brake for main spindle                   |                       | O       | O       | O       | O       |
| Lubrication system                            |                       | S       | S       | S       | S       |
| <b>WORK HOLDING</b>                           |                       |         |         |         |         |
| 4-jaws manual chuck                           |                       | S       | S       | S       | S       |
| <b>LIVE TOOLING SPINDLE</b>                   |                       |         |         |         |         |
| BT50 spindle                                  |                       | S       | S       | S       | S       |
| Spindle Coolant                               |                       | S       | S       | S       | S       |
| Coolant through spindle ( CTS )               |                       | S       | S       | S       | S       |
| Drilling & milling function                   |                       | O       | O       | O       | O       |
| 12T magazine                                  |                       | S       | -       | -       | -       |
| 16T magazine                                  |                       | O       | S       | S       | S       |
| 24T magazine                                  |                       | O       | O       | O       | O       |
| <b>MRASUREMENT</b>                            |                       |         |         |         |         |
| Tool presetter                                |                       | O       | O       | O       | O       |
| X & Z axes linear scales                      |                       | O       | O       | O       | O       |
| Part presence check                           |                       | O       | O       | O       | O       |
| <b>COOLANT</b>                                |                       |         |         |         |         |
| Coolant pump                                  | 10 Kg/cm <sup>2</sup> | S       | S       | S       | S       |
| High-pressure coolant system *1               | 20 Kg/cm <sup>2</sup> | O       | O       | O       | O       |
| Oil skimmer                                   |                       | O       | O       | O       | O       |
| Coolant flow switch                           |                       | O       | O       | O       | O       |
| Coolant level switch                          |                       | O       | O       | O       | O       |
| Coolant intercooler system                    |                       | O       | O       | O       | O       |
| Paper tape filter                             |                       | O       | O       | O       | O       |
| <b>CHIP DISPOSAL</b>                          |                       |         |         |         |         |
| Chip conveyor                                 |                       | S       | S       | S       | S       |
| Chip cart                                     |                       | O       | O       | O       | O       |
| <b>SAFETY</b>                                 |                       |         |         |         |         |
| Fully enclosed splash guard                   |                       | S       | S       | S       | S       |
| Door interlock ( incl. Mechanical lock )      |                       | S       | S       | S       | S       |
| Impact resistant viewing window               |                       | S       | S       | S       | S       |
| Low hydraulic pressure detection switch       |                       | S       | S       | S       | S       |
| Over travel ( soft limit )                    |                       | S       | S       | S       | S       |
| Auto power-off device                         |                       | S       | S       | S       | S       |
| <b>OTHERS</b>                                 |                       |         |         |         |         |
| Tri-color operation status signal light tower |                       | O       | O       | O       | O       |
| Florescent work light                         |                       | S       | S       | S       | S       |
| Electrical cabinet                            | Heat exchanger        | S       | S       | S       | S       |
|   | A / C cooling system  | O       | O       | O       | O       |
| Complete hydraulic system                     |                       | S       | S       | S       | S       |
| Advanced auto lubrication system              |                       | S       | S       | S       | S       |
| Emergency maintenance electrical part package |                       | S       | S       | S       | S       |
| Operation & maintenance manuals               |                       | S       | S       | S       | S       |

\*1 Higher pressure request please see page 9 or contact with Goodway.

|  |                   | Oi-TF | 31i |
|--|-------------------|-------|-----|
| <b>FANUC CONTROL FUNCTIONS</b>                   |                   |       |     |
| Display  | 10.4" color LCD   | S     | S   |
| Graphic function                                 | Standard          | S     | -   |
|  | Dynamic *2        | O     | S   |
|  | 512K bytes        | S     | -   |
| Part program storage size                        | 1M bytes          | -     | S   |
|  | Oi-TF : each path | O     | O   |
|  | 31i : total       | -     | O   |
|  | 8M bytes          | -     | O   |
| Registerable programs                            | 400               | S     | -   |
|  | Oi-TF : each path | O     | S   |
|  | 31i : total       | -     | O   |
|  | 99                | -     | S   |
| Tool offset pairs                                | 128               | S     | -   |
|  | 200               | O     | O   |
|  | Oi-TF : each path | -     | O   |
|  | 31i : total       | -     | O   |
|  | 499               | -     | O   |
|  | 999               | -     | O   |
|  | 2000              | -     | O   |
|  | Servo HRV control | HRV 3 | S   |
| Automatic data backup                            |                   | S     | S   |
| Synchronous / Composite control                  |                   | O     | O   |
| Inch / metric conversion                         |                   | S     | S   |
| Polar coordinate interpolation                   |                   | S     | S   |
| Cylindrical interpolation                        |                   | S     | S   |
| Multiple repetitive cycle                        |                   | S     | S   |
| Rigid tapping                                    |                   | S     | S   |
| Unexpected disturbance torque detection function |                   | S     | S   |
| Spindle orientation                              |                   | S     | S   |
| Spindle speed fluctuation detection              |                   | S     | S   |
| Embedded macro                                   |                   | O     | O   |
| Spindle synchronous control                      |                   | S     | S   |
| Run hour and parts count display                 |                   | S     | S   |
| Tool radius / Tool nose radius compensation      |                   | S     | S   |
| Polygon turning                                  |                   | S     | S   |
| Helical interpolation                            |                   | O     | O   |
| Direct drawing dimension programming             |                   | S     | S   |
| Thread cutting retract                           |                   | S     | S   |
| Variable lead threading                          |                   | S     | S   |
| Multiple repetitive cycle II                     |                   | S     | S   |
| Canned cycles for drilling                       |                   | S     | S   |
| Tool nose radius compensation                    |                   | S     | S   |
| Chamfering / Corner R                            |                   | S     | S   |
| AI contour control I                             |                   | O     | S   |
| Multi part program editing                       |                   | S     | S   |
| Manual handle retrace                            |                   | O     | O   |
| Manual intervention and return                   |                   | S     | O   |
| External data input                              |                   | S     | S   |
| Addition of custom macro                         |                   | S     | S   |
| Increment system C                               |                   | S     | S   |
| Run hour & parts counter                         |                   | S     | S   |
| Auto power-off function                          |                   | S     | S   |
| RS-232 port                                      |                   | S     | S   |
| Memory card input / output ( CF + USB )          |                   | S     | S   |
| Ethernet   |                   | S     | S   |

\*2 Dynamic graphic display conflict to MANUAL GUIDE *i*, only can choose one to have.

MANUAL GUIDE *i* is standard on 31i controller.

Specifications are subject to change without notice.



# MACHINE SPECIFICATIONS

■ : Metric ■ : Inch

| CAPACITY                                 | GV-1100  | GV-1200   | GV-1600   | GV-2000   |                                  |
|--|--|---|---|---|----------------------------------|
| Table diameter                           | Ø 1,100 mm 43.3"   | Ø 1,250 mm 49.2"  | Ø 1,600 mm 62.9"  | Ø 2,000 mm 78.7"  |                                  |
| Max. swing diameter                      | Ø 1,400 mm 55.1"   | Ø 1,600 mm 62.9"  | Ø 2,000 mm 78.7"  | Ø 2,050 mm 80.7"  |                                  |
| Max. turning diameter                    | Ø 1,200 mm 47.2"   | Ø 1,350 mm 53.1"  | Ø 1,800 mm 70.8"  | Ø 2,000 mm 78.7"  |                                  |
| Max. turning height                      | 1,000 mm 39.3"   | 1,300 mm 51.1"  |   | 1,280 mm 50.39"   |                                  |
| Max. table load                          | 4,000 kg 8,800 lb  | 5,000 kg 11,000 lb                                      | 8,000 kg 17,600 lb                                      | 5,000 kg 11,000 lb                                      | 8,000 kg <sup>*1</sup> 17,600 lb |
| <b>WORK PIECE SPINDLE</b>                |  |   |   |   |                                  |
| Spindle bearing diameter                 | Ø 350 mm 13.77"  | Ø 423 mm 16.65"   | Ø 580 mm 22.83"   | Ø 580 mm 22.83"   | Ø 690 mm <sup>*1</sup> 27.16"    |
| Motor output ( Cont. )                   | 37 kW 50 HP  |   |   |   |                                  |
| Motor output ( 30 min. )                 | 45 kW 60 HP  |   |   |   |                                  |
| Gear step                                | 2-speed  |   |   |   |                                  |
| Spindle speed range                      | 1 ~ 500 rpm  | 2 ~ 350 rpm   | 2 ~ 250 rpm   | 2 ~ 200 rpm   |                                  |
| Max. spindle torque                      | 10,170 Nm 7,500 lb-ft  | 17,100 Nm 12,600 lb-ft                                  | 23,900 Nm 17,600 lb-ft                                  | 23,900 Nm 17,600 lb-ft                                  |                                  |
| <b>Cf-AXIS ( OPTIONAL )</b>              |  |   |   |   |                                  |
| Motor output                             | 3 kW 4 HP  |   |   |   |                                  |
| Cf-axis speed range                      | 15 rpm   | 13 rpm  | 9 rpm   | 9 rpm   |                                  |
| Cf-axis torque output                    | 2,280 Nm 1,680 lb-ft   | 2,740 Nm 2,000 lb-ft                                    | 3,840 Nm 2,800 lb-ft                                    | 3,840 Nm 2,800 lb-ft                                    |                                  |
| <b>LIVE TOOLING SPINDLE ( OPTIONAL )</b> |  |   |   |   |                                  |
| Motor output ( Cont. )                   | 7.5 kW 10 HP   | 11 kW 15 HP   |   |   |                                  |
| Motor output ( 30 min. )                 | 11 kW 15 HP  | 15 kW 20 HP   |   |   |                                  |
| Spindle speed range                      | 2 ~ 2,400 rpm  |   |   |   |                                  |
| <b>X &amp; Z AXES</b>                    |  |   |   |   |                                  |
| Max. X-axis travel                       | 1,300 ( -100 ~ 1,200 ) mm<br>51.18" ( -3.93" ~ 47.24" )                            | 1,375 ( -100 ~ 1,275 ) mm<br>54.13" ( -3.93" ~ 50.19" ) | 1,600 ( -100 ~ 1,500 ) mm<br>62.99" ( -3.93" ~ 59.05" ) | 1,700 ( -100 ~ 1,600 ) mm<br>66.92" ( -3.93" ~ 62.99" ) |                                  |
| Max. Z-axis travel                       | 900 mm 35.43"  |   |   |   |                                  |
| Max. W-axis travel                       | 600 mm 23.62"  | 800 mm 31.49"   |   |   |                                  |
| X / Z axes rapids                        | 12 / 10 m/min. 472 / 393 IPM   |   |   |   |                                  |
| X-axis servo motor output                | 7 kW 9.3 HP  | 6 kW 8 HP   |   |   |                                  |
| Z-axis servo motor output                | 9 kW 12 HP   |   |   |   |                                  |
| <b>ATC</b>                               |  |   |   |   |                                  |
| Magazine capacity                        | 12   | 16  |   |   |                                  |
| Spindle taper                            | BT50 ( CAT50 )   |   |   |   |                                  |
| Max. tool size ( L × W × H )             | 280 x 150 x 400 mm 11" x 5.9" x 15.7"  |   |   |   |                                  |
| Max. tool weight                         | 50 kg 110 lb   |   |   |   |                                  |
| Max. magazine load                       | 360 kg 790 lb  |   |   |   |                                  |
| <b>GENERAL</b>                           |  |   |   |   |                                  |
| Positioning accuracy                     | ± 0.007 / 500 mm ± 0.0003" / 19.7" ( X & Z axes ), ± 7.5 arc.sec / 360° ( C-axis ) |   |   |   |                                  |
| Repeatability                            | ± 0.005 mm ± 0.0002" ( X & Z axes ), ± 4 arc.sec / 360° ( C-axis )                 |   |   |   |                                  |
| Standard CNC control                     | FANUC Oi -TF   |   |   |   |                                  |
| Voltage / Power requirement              | AC 200 / 220 + 10 % to -15 % 3 phase /100 KVA                                      |   |   |   |                                  |
| Hydraulic capacity                       | 50 L 13 gal  |   |   |   |                                  |
| Coolant tank capacity                    | 900 L 237 gal  |   |   |   |                                  |
| Machine weight                           | 20,000 kg 44,100 lb  | 23,500 kg 51,900 lb                                     | 25,500 kg 56,300 lb                                     | 27,000 kg 59,600 lb                                     |                                  |
| Dimensions ( L × W × H )                 | 3,485 x 3,930 x 5,050 mm<br>138" x 155" x 199"                                     | 3,540 x 3,695 x 5,300 mm<br>140" x 146" x 209"          | 3,790 x 3,950 x 5,300 mm<br>150" x 156" x 209"          | 4,400 x 4,100 x 5,700 mm<br>174" x 162" x 225"          |                                  |

\*1 Optional

Specifications are subject to change without notice.



GOODWAYCNC.com

## GOODWAY MACHINE CORP.

### HEADQUARTERS

No.13, 5<sup>th</sup> Road,  
Taichung Industrial Park,  
Taichung City, 407, Taiwan  
E-mail : [goodway@goodwaycnc.com](mailto:goodway@goodwaycnc.com)

### CENTRAL TAIWAN SCIENCE PARK BRANCH

No. 38, Keyuan Road,  
Central Taiwan Science Park.Taichung,  
Taichung City, 407, Taiwan  
TEL : + 886-4-2463-6000  
FAX : + 886-4-2463-9600

### GOODWAY MACHINE ( WUJIANG ) CO.,LTD

No. 4888, East Lake Taihu Avenue, Wujiang  
Economic and Technological Development Zone,  
Jiangsu, China  
Sales Hotline : + 86-512-8286-8068  
Service Hotline : + 86-512-8286-8066  
FAX : + 86-512-8286-8620  
E-mail : [goodway@goodwaycnc.cn](mailto:goodway@goodwaycnc.cn)